

PKOM⁴ & PSOL⁺ SYSTEM SOLUTION

Ventilating. Heating. Cooling. Hot water.
Combined with renewable energy.

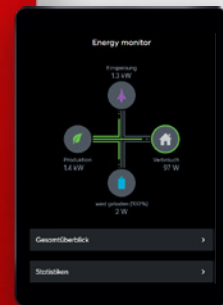
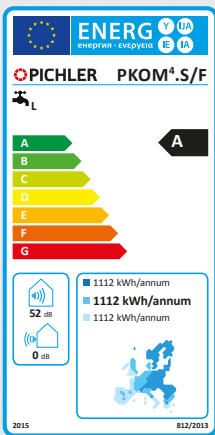

 **PICHLER**

Systematic ventilation.

Product description

PKOM⁴ & PSOL+: TWO COMPONENTS FOR A COMPLETE SYSTEM SOLUTION

The combination of PKOM⁴ and PSOL+ is the easiest solution to integrate intelligent ventilation and heat pump technology with renewable energy in a single unit. The result is a complete system solution with optimal synergy effects, excellent energy efficiency, environmentally friendly clean energy and perfect living comfort – all of this from a single source, and displayable using the PICHLER app.

COMPONENT 1: PKOM⁴ HEAT PUMP COMBINATION UNIT

The patented PKOM⁴ heat pump combination unit is a compact ventilation system that replaces a fully fledged heating/cooling/hot water system. Compact and super-efficient, extremely quiet and low-maintenance to operate, environmentally friendly heat pump technology, low operating costs, simple and intuitive operation using a touchscreen display – the PKOM⁴ has it all. Combining it with renewable energy such as photovoltaics and energy management makes the PKOM⁴ an efficient, cost-effective system solution, which reduces operating costs to a minimum, making your home a zero-energy or even plus-energy house.

COMPONENT 2: SOLARTOWER PSOL+

The compact PKOM⁴ is also being combined into an efficient, cost-effective system solution for the future with renewable energies with a second cornerstone, the PSOL+. This pre-assembled and installed complete solution in a single, sleek and compact housing comprises:

- Integrated battery storage
- A hybrid inverter
- An energy management system for system optimisation with the PKOM⁴ heat pump combination device.

Various system sizes enable optimal adaptation to any building. All versions benefit from simple installation and hence, reduced installation costs.

All components are wired at our plant and are fitted with terminals and/or plugs. The connections (supply, DC connections via the tool-free PV plug included in the delivery, Modbus connection for smart meter) are mounted centrally on the top of the unit.

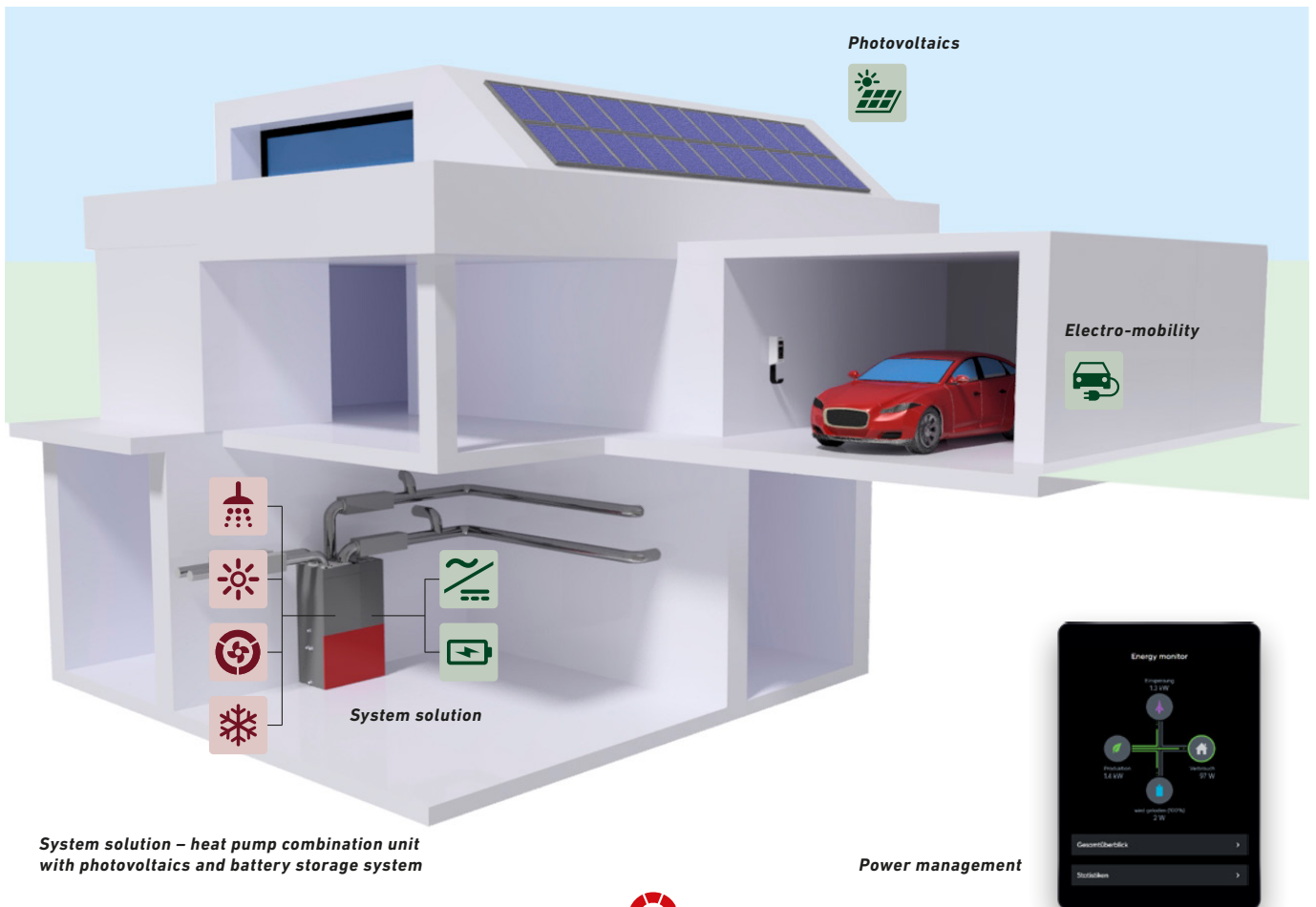

System solution – heat pump combination unit with photovoltaics and battery storage system

Power management



Versions

COMPONENT 1: PKOM⁴ HEAT PUMP COMBI UNIT

The PKOM⁴ heat pump combination unit is available with either a standard or enthalpy heat exchanger. Compared to the standard heat exchanger, the enthalpy

exchanger will recover not only heat from the extract air, but also a large percentage of the humidity. This humidity-heat exchanger will therefore ensure a pleasant indoor climate especially in cold months.

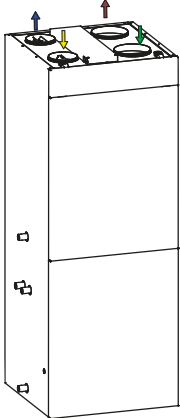
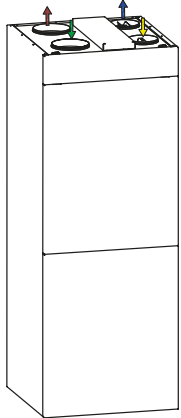
Article PKOM ⁴ classic	Left-handed version	Right-handed version
with standard heat exchanger and Heating battery in the storage tank	08PKOM4LSW	08PKOM4RSW
with enthalpy exchanger* and Heating battery in the storage tank	08PKOM4LFW	08PKOM4RFW
		

COMPONENT 2: SOLARTOWER PSOL+

The Solartower PSOL+ is available in a wide range of versions, which first requires determining the correct dimensioning of the building together with the photovoltaic system.

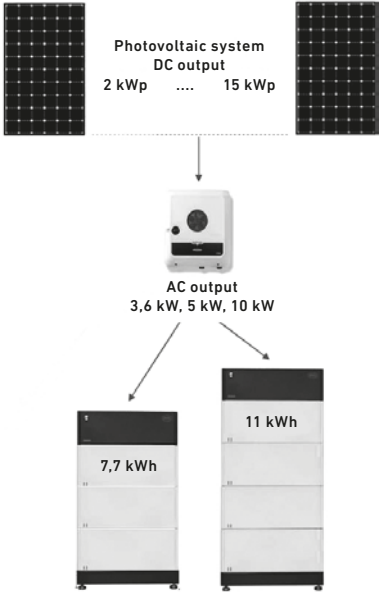
Article SOLARTOWER PSOL+ with energy management	Description	Item number	Emergency power capable ¹	Version	
SOLARTOWER PSOL PLUS 5/7	5kW ² Fronius Symo GEN24 Plus; 7,7 kWh BYD HVS Premium Batterie	08PSOLP0507	NO	3-phase design	
SOLARTOWER PSOL PLUS 5/11	5kW ² Fronius Symo GEN24 Plus; 11 kWh BYD HVM Premium Batterie	08PSOLP0511	NO		
SOLARTOWER PSOL PLUS 10/7	10kW ² Fronius Symo GEN24 Plus; 7,7 kWh BYD HVS Premium Batterie	08PSOLP1007	YES		
SOLARTOWER PSOL PLUS 10/11	10kW ² Fronius Symo GEN24 Plus; 11 kWh BYD HVM Premium Batterie	08PSOLP1011	YES	1-phase design	
SOLARTOWER PSOL PLUS SPH 3/7	3,6kW ² Fronius Symo GEN24 Plus; 7,7 kWh BYD HVS Premium Batterie	08PSOLPSPH0307	YES		
SOLARTOWER PSOL PLUS SPH 3/11	3,6kW ² Fronius Symo GEN24 Plus; 11 kWh BYD HVM Premium Batterie	08PSOLPSPH0311	YES		

¹ The emergency power function is not included in the scope of supply and must be installed and configured on site.

² AC output

Dimensions

PKOM⁴ HEAT PUMP COMBI UNIT & SOLARTOWER PSOL⁺

(W x H x D): 1222 x 2012 x 734 mm

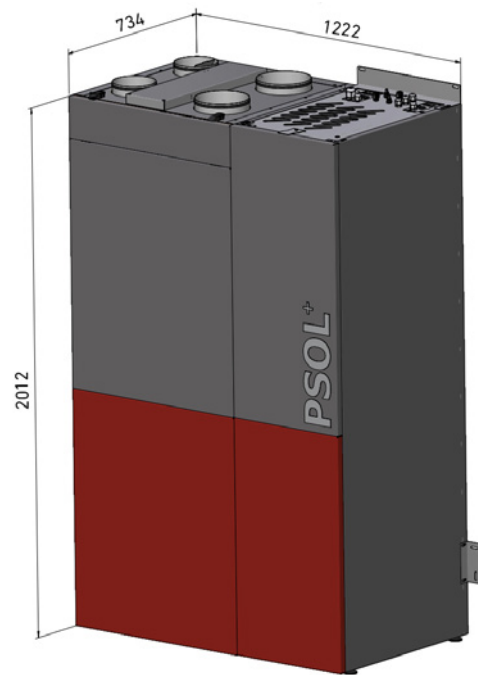

Layout Sketch

COMPONENT 1: PKOM⁴ HEAT PUMP COMBI UNIT



REFERRING TO ITEM 15

*Patented two-circuit
heat pump system*

- Allows for especially efficient operation
- Both heat pumps can be operated in parallel
- Increases the efficiency of the heat pump and the annual seasonal energy efficiency ratio of the domestic water and heating water pump
- Allows for especially efficient cooling operation while generating hot water at the same time
- The waste heat that is generated during the cooling operation is recovered for the purpose of heating the service water

Dimensions (W x H x D): 741 x 2012 x 734 mm

Weight: 240 kg

PKOM⁴ classic (right-handed version)

- | | |
|---------------------------------------|--|
| 1 Supply air (SUP) | 14 Compressor in housing |
| 2 Extract air (ETA) | 15 Heat exchanger in exhaust air |
| 3 Outdoor air (ODA) | 16 Heat exchanger in supply air |
| 4 Exhaust air (EHA) | 17 Condensate tray |
| 5 Filter ODA ISO ePM1 55% | 18 Household hot water tank |
| 6 Filter ETA ISO ePM10 75% | 19 Impressed current anode |
| 7 Outdoor air fan | 20 Electrical heating element with thermal cut-out |
| 8 Extract air fan | 21 Hot water connection 1"AG |
| 9 Bypass flap with servo motor | 22 Heating battery connection 1"AG |
| 10 Pre-heater battery for outdoor air | 23 Cold water connection 1"AG |
| 11 Counterflow heat exchanger | 24 Condensate drain |
| 12 ODA/EHA flap with servo motor | 25 Electrical connection box with main PCB |
| 13 ODA/SUP flap with servo motor | 26 Heat pump PCB |

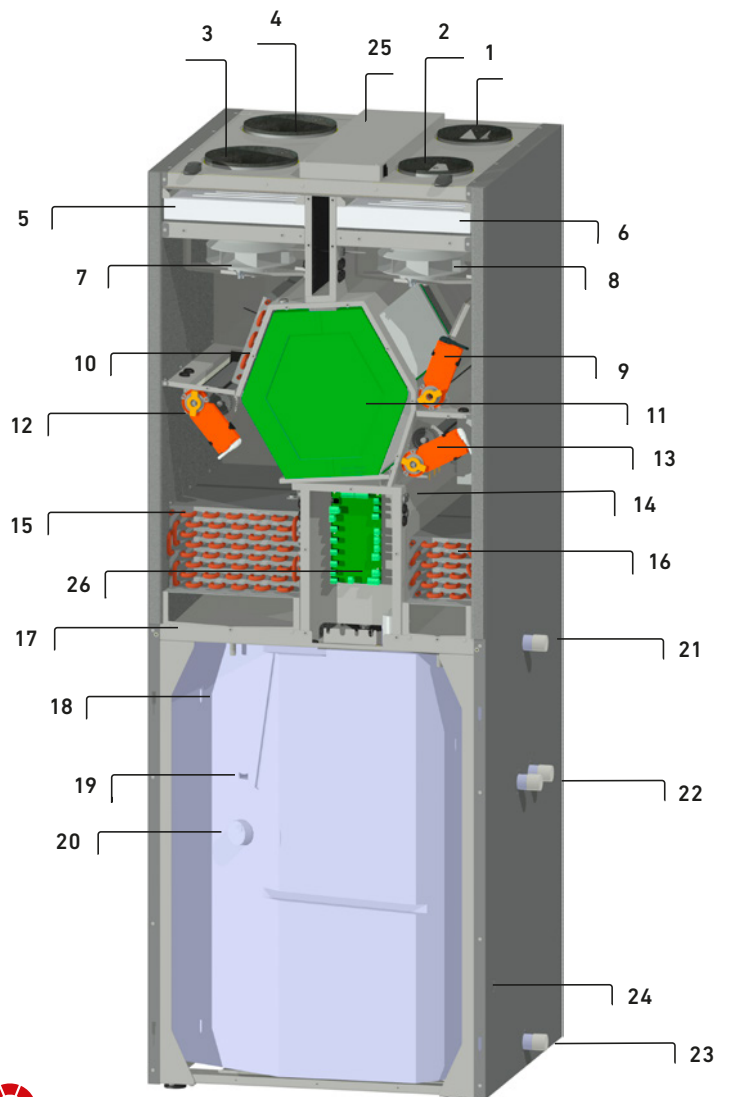

Layout sketch

COMPONENT 2: SOLARTOWER PSOL+

- Fronius hybrid inverter
- BYD battery storage
- Loxone energy management for system optimisation
- APP / visualisation

Dimensions (W x H x D): 480 x 2012 x 734 mm

Weight: 96 kg

Advantages:

- Pre-assembled and pre-installed compact solution
- Plug & play
- Lower installation costs
- High degree of personal energy usage of the photovoltaics system
- APP / visualisation
- Everything from a single source – a single contact person

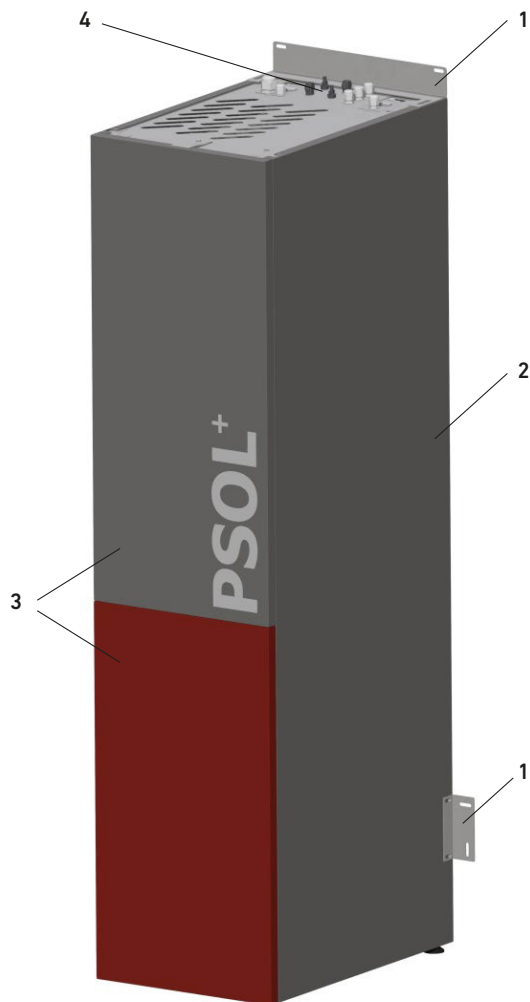

- 1 Wall mounting
- 2 Casing
- 3 Front covers
- 4 Electrical connections

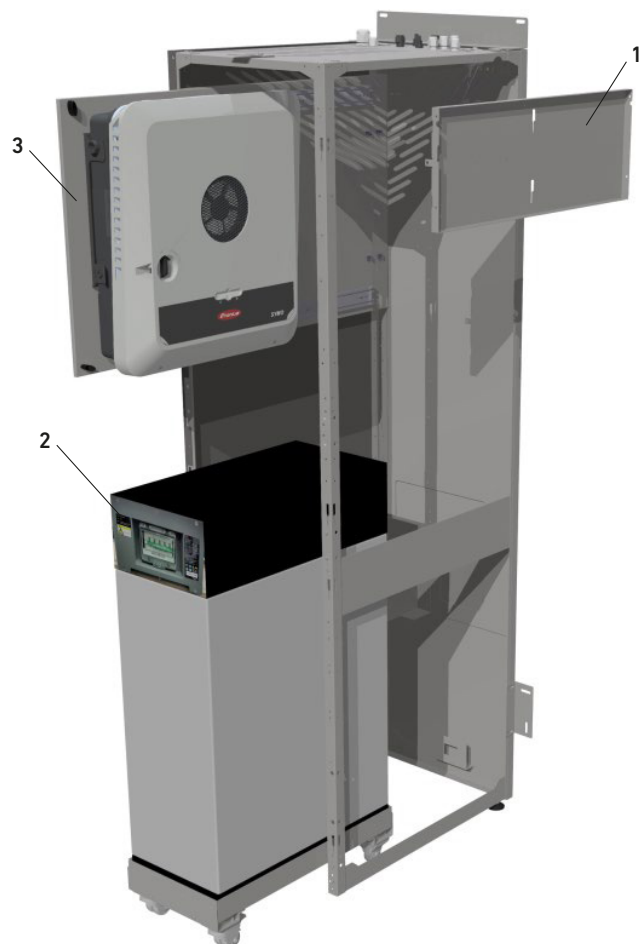

- 1 Energy manager
- 2 BYD battery
- 3 Inverter



Power management

Energy monitoring provides access to detailed information about the PKOM⁴ & PSOL+ system solution at any time, including room and domestic water temperatures, as well as information about the photovoltaic system and battery management. Production, consumption and feed-in can be displayed graphically at various time intervals.

A series of algorithms determine demand-driven regulation of the system solution influenced by the energy supply.

The result is further energy optimisation and increased consumption of your own electricity – operating costs can thereby be reduced to a minimum.

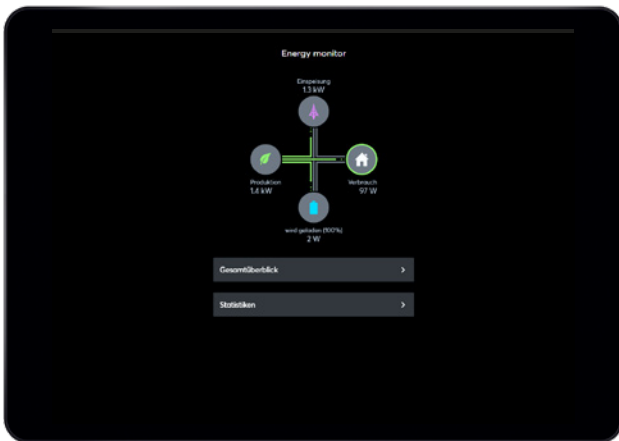

Energy monitor: All essential energy flows are visible at a glance: current PV power produced, energy consumption/feed-in or battery charge level, as well as historical data.

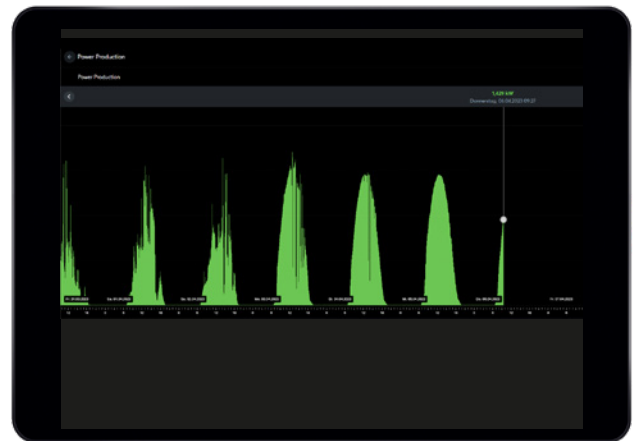

System optimisation: ECO mode for ventilation, heating, cooling and hot water preparation activates the control algorithms for particularly energy-optimized operation, taking into account the currently and freely available PV power as well as the battery charge level.

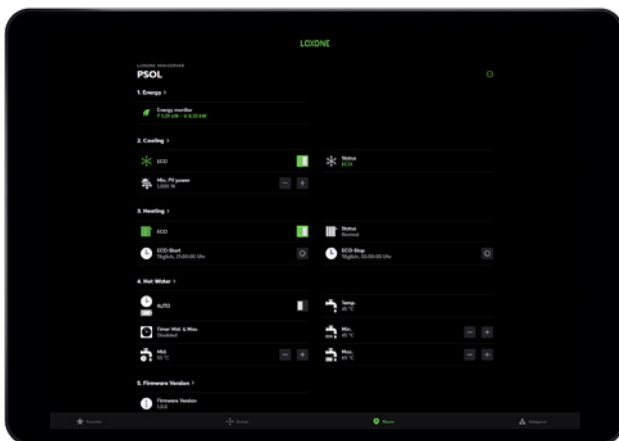

Menu: The preset values can be modified and adapted to your own needs in the app or Web browser.



Awards



NETZWERK PASSIVHAUS INNOVATIONS AWARD 2021

PICHLER is awarded as the "MOST INNOVATIVE Passive House Network Member Company 2021" for the special system solution PKOM⁴ & PSOL+ and as the "BEST Network Passive House Team of the year 2021" in the multi-storey residential building category.



TRIGOS REGIONAL 2020

With the PKOM⁴ system solution Pichler is winning the Austrian sustainability prize TRIGOS Regional 2020 in the category "Climate protection". The TRIGOS is the most renowned and respected sustainability award in Austria. The prize is awarded to sustainable companies for high-quality products and services.

As the TRIGOS jury makes clear, "J. Pichler GmbH has developed a compact heat pump combination unit that covers ventilation, heating, cooling and hot water. The integration of photovoltaics and an energy management system created an efficient, cost-effective overall solution that is easy and intuitive to use. The dedicated family business makes an excellent contribution to reducing energy consumption and minimising CO₂ emissions in the building sector. The company's sustainability efforts are clearly evident. Above all, the jury praised the company's science-based strategy and approach. Heating, cooling and ventilation with the lowest possible energy consumption is one of THE topics of the future and plays a role in climate protection and CO₂ reduction. The jury sees the J. Pichler GmbH project as an important development engine for climate-friendly living."



System solution PKOM⁴ & PSOL+, at a glance

- Pre-assembled / installed overall solution
- Plug & play – easy, reliable
- Lower installation/energy costs
- Everything from one single source – one contact person
- One app / visualization
- Independent in the event of power failures – emergency power function
- High degree of personal energy usage of the photovoltaics system



Your partner/installer:



Responsible for the content: J. Pichler Gesellschaft m.b.H. | Graphics and layout: WERK1
 Photos: J. Pichler Gesellschaft m.b.H. | Text: J. Pichler Gesellschaft m.b.H.
 All rights reserved | All photos are symbolic photos | Subject to change without notice | Version: 10/2024 en/p



J. PICHLER
 Gesellschaft m.b.H.
 office@pichlerluft.at
 www.pichlerluft.at

AUSTRIA
 9021 KLAGENFURT
 AM WÖRTHERSEE
 Karlweg 5
 T +43 (0)463 32769
 F +43 (0)463 37548

AUSTRIA
 1100 WIEN
 Doerenkampgasse 5
 T +43 (0)1 6880988
 F +43 (0)1 6880988-13

Sales offices in Germany, Slovenia and Serbia.
 Sales partners in Europe.