

COMPACT VENTILATION UNIT LG 740



**COMFORT
VENTILATION**



EU Regulation
1253/2014



EPREL according
to Regulation (EU)
No. 1369/2017

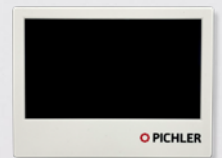

 **PICHLER**

Systematic ventilation.

Product description

The LG 740 compact ventilation unit consists of a compact, thermally insulated, thermal bridge-free housing made of galvanised sheet steel, powder-coated in RAL 9003.

It has a highly efficient heat recovery system with an air/air counterflow heat exchanger, optionally with moisture recovery (enthalpy exchanger), an automatic 100% bypass and energy-saving centrifugal fans with the latest EC motor technology.

If used as a school ventilation unit, the compact ventilation unit comes equipped with an automatic temperature- and time-controlled night cooling function to prevent overheating in the summer.

The night cooling function serves to reduce the room temperature and helps the structure and fixtures to cool down. The unit can be started via adjustable time programmes or by means of a presence detector (surcharge).

The integrated air flow rate measurement guarantees balanced operation with constant flow on the supply and extract air sides. An expansion option to implement constant pressure control is also optionally available.

The standard air filters used are ODA filters ISO ePM1 55% for the outside air and ETA filters ISO Coarse 70% for the extract air. The controller is equipped as standard with a LAN interface for the

Internet connection. The filter can be changed without tools when the front of the device is closed.

The unit is operated easily and intuitively using the MINI or (optional) TOUCH control unit or the Pichler app when connected to the Internet. The optional expansion options with the CO₂, humidity and room temperature sensors enable demand-controlled ventilation operation. The LG 740 compact ventilation unit is suitable for standing installation in frost-free rooms.

The device design meets the hygienic requirements of VDI 6022.

Area of application

The LG 740 compact ventilation unit is used for controlled, mechanical ventilation of homes, large residential units and offices and for similar purposes. The area of use has an air volume flow range of

150 - 750 m³/h. The LG 740 can also be used as a decentralised ventilation unit in small and medium-sized classrooms. System-integrated silencers ensure low-noise operation even with high air

volume flows. The specially developed condensate avoidance function in combination with an enthalpy exchanger and a humidity sensor enables condensate-free operation of the ventilation unit.



Design drawing (free-standing installation, left-hand version)

Dimensions: (W x H x D) 1090 x 940 x 660 mm

Air line connection: 4 x Ø 200 mm

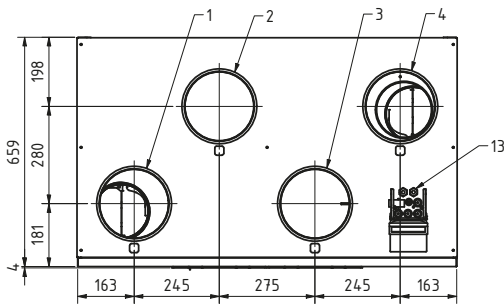
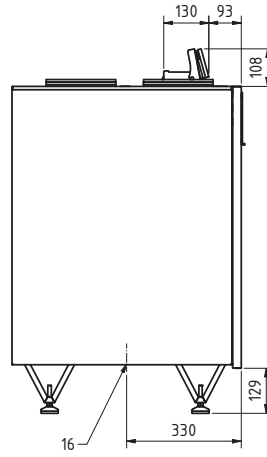
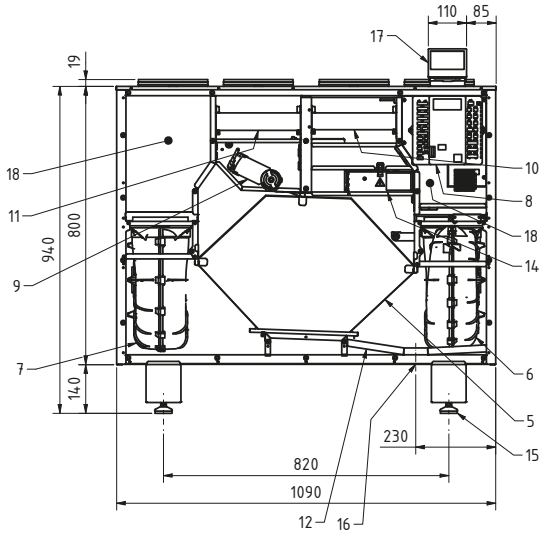

- 1 Supply air DN200
- 2 Extract air DN200
- 3 Outdoor air DN200
- 4 Exhaust air DN200
- 5 Counterflow heat exchanger (optionally with moisture recovery)
- 6 Exhaust air fan
- 7 Supply air fan
- 8 Controller
- 9 Bypass flap drive
- 10 ODA filter ISO ePM1 55%
- 11 ETA filter ISO Coarse 70%
- 12 Condensate tray
- 13 Cable inlets
- 14 Electric pre-heating coil (optional)
- 15 Height-adjustable feet
- 16 Hot water connection 1 ¼" outside thread
- 17 Mounting bracket for the MINI or TOUCH control units
- 18 Integrated acoustic dampeners (supply and exhaust air)

Illustration: LG 740 (left-hand version)



Design drawing (free-standing installation, right-hand version)

Dimensions: (W x H x D) 1090 x 940 x 660 mm

Air line connection: 4 x Ø 200 mm

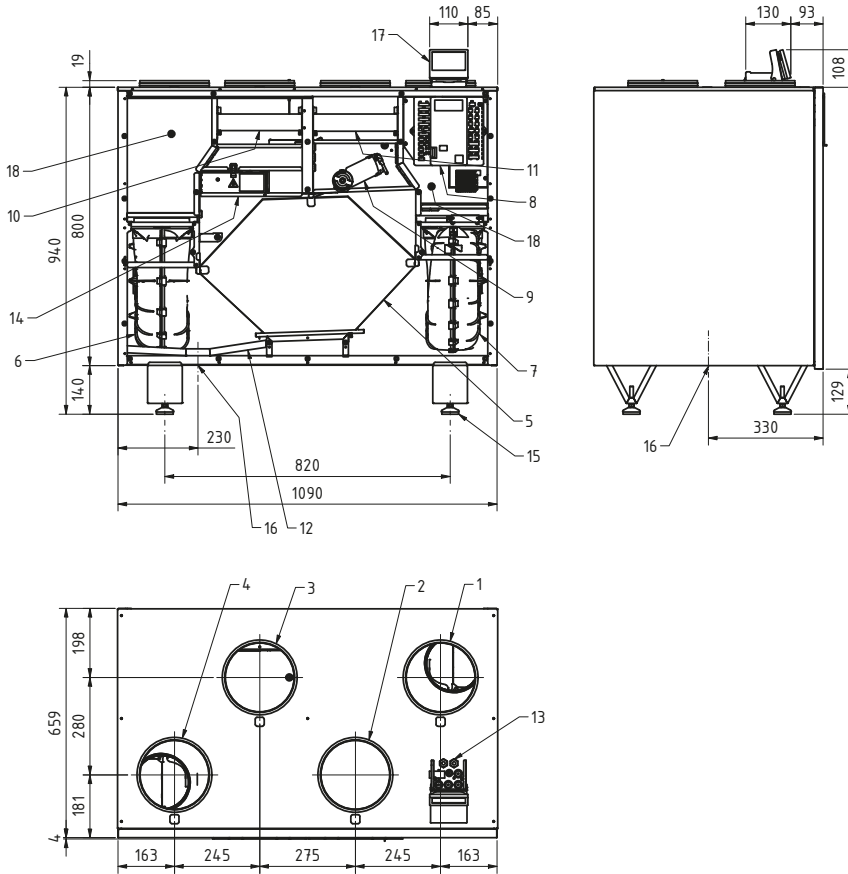





- 1 Supply air DN200
- 2 Extract air DN200
- 3 Outdoor air DN200
- 4 Exhaust air DN200
- 5 Counterflow heat exchanger (optionally with moisture recovery)
- 6 Exhaust air fan
- 7 Supply air fan
- 8 Controller
- 9 Bypass flap drive
- 10 ODA filter ISO ePM1 55%
- 11 ETA filter ISO Coarse 70%
- 12 Condensate tray
- 13 Cable inlets
- 14 Electric pre-heating coil (optional)
- 15 Height-adjustable feet
- 16 Hot water connection 1 1/4" outside thread
- 17 Mounting bracket for the MINI or TOUCH control units
- 18 Integrated acoustic dampeners (supply and exhaust air)

Illustration: LG 740 (right-hand version)







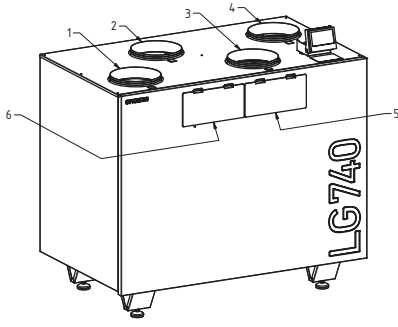
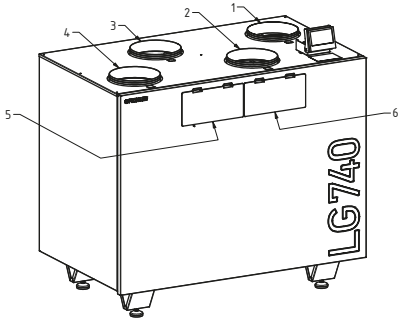



Versions

LG 740

Standing installation LG 740	Left-hand version	Right-hand version
Article no. without pre-heating coil	08LG740L	08LG740R
Article no. with integrated pre-heating coil	08LG740LV	08LG740RV
Article no. with enthalpy exchanger	08LG740LF	08LG740RF
Article no. with enthalpy exchanger and integrated pre-heating coil	08LG740LFV	08LG740RFV
 1 Supply air  2 Extract air  3 Outdoor air  4 Exhaust air 5 Filter revision outdoor air 6 Filter revision extract air		

Overview of energy efficiency classes

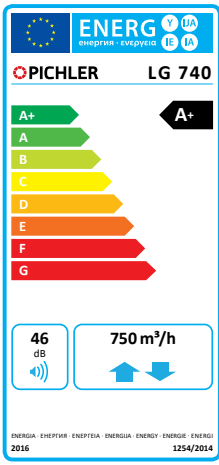
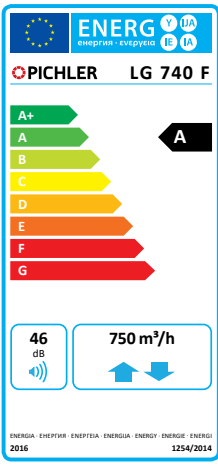
	LG 740 (V)	LG 740 F (V)
Manual control		
Timer		
Central demand control		
Local demand control		
		



Download the product data sheets from www.pichlerluft.at



Technical specifications

Equipment type	LG 740 (V)	LG 740 F (V)
Heat exchanger	Standard	Enthalpy exchanger
Air volume flow min. - max. (adjustable in steps of 5 m ³ /h)	150 - 750 m ³ /h	150 - 750 m ³ /h

Characteristic values in compliance with EN13141-7:2011		
Temperature ratio $\eta_{\text{O,SU}}^{1,2}$	85.5%	80.5%
Temperature ratio $\eta_{\text{O,EX}}^{1,2}$	77.4%	72.5%
Specific power input SPI ^{1,2}	0.20 Wh/m ³	0.20 Wh/m ³
Humidity ratio η_{xSU}		70%
External leakage	< 1%	
Internal leakage	< 1%	

Classification of air filters in accordance with EN ISO 16890		
 ODA filter (outdoor air)		ISO ePM1 55%
 ETA filter (extract air)		ISO Coarse 70%

Operating conditions		
Permissible ambient temperature (place of installation)		+5 to +35 °C
Permissible operating temperature (outside air)		-15 to +35 °C

Electrical system		
Electrical connection		230 V / L/N/PE / 50 Hz / 16 A
IP classification		IP40 with connected air ducts
Max. power without pre-heating coil		400 W
Max. power with pre-heating coil		2,800 W

Materials		
Inner part		Polyethylene insulating materials and galvanized sheet steel
Housing		Galvanized sheet steel and powder-coated in RAL 9003
Heat exchanger		Aluminium counterflow exchanger
Enthalpy exchanger		Aluminium and polymer membrane counterflow exchanger

Housing		
Air line connections		4 x Ø 200 mm (nipples with SAFE double lip seal)
Condensate drainage		Outside thread 1¼"
Dimensions (W x H x D)		1090 x 940x 660 mm
Weight without optional accessories		120 kg

1) At 70% of the max. volume flow

2) According to the calculations as per prEN13171-7:2018 based on an air temperature of 20 °C



ACOUSTIC SPECIFICATIONS

LG 740		Item	Housing radiation			Outdoor air connector			Supply air inlet			Exhaust air connector			Extract air outlet		
		m ³ /h	300	525	750	300	525	750	300	525	750	300	525	750	300	525	750
		Pa	50	50	100	50	50	100	50	50	100	50	50	100	50	50	100
Midband frequency	125 Hz	L _y in dB	48	46	49	45	46	53	60	53	60	57	53	61	49	47	54
	250 Hz		41	54	62	40	59	59	53	69	77	48	62	76	41	58	60
	500 Hz		37	44	51	37	47	54	47	57	64	45	57	65	36	46	54
	1000 Hz		23	35	43	29	42	50	38	49	57	37	47	57	29	40	49
	2000 Hz		21	29	37	23	39	48	31	44	53	28	43	53	20	33	42
	4000 Hz		14	14	25	16	29	41	20	37	48	18	34	47	16	23	34
	8000 Hz		10	14	21	16	19	32	17	30	44	16	26	43	16	17	25
	Total L _{WA} in dB(A)		38	46	56	38	51	57	50	61	71	47	56	70	39	50	56

Note: Tolerances for sound data ±2 dB, measured in compliance with EN ISO 9614-2

External pressure boost characteristics – air flow rate

The characteristic curves shown are valid for the device version with ODA filter ISO ePM1 55% (outdoor air) and ETA filter ISO Coarse 70% (extract air). The specified total output takes into account the power consumption for the two

fans in the supply and exhaust air as well as the power consumption of the control. **Note:** Depending on the installed air duct system, the maximum air volume flow may not be achieved in bypass mode.

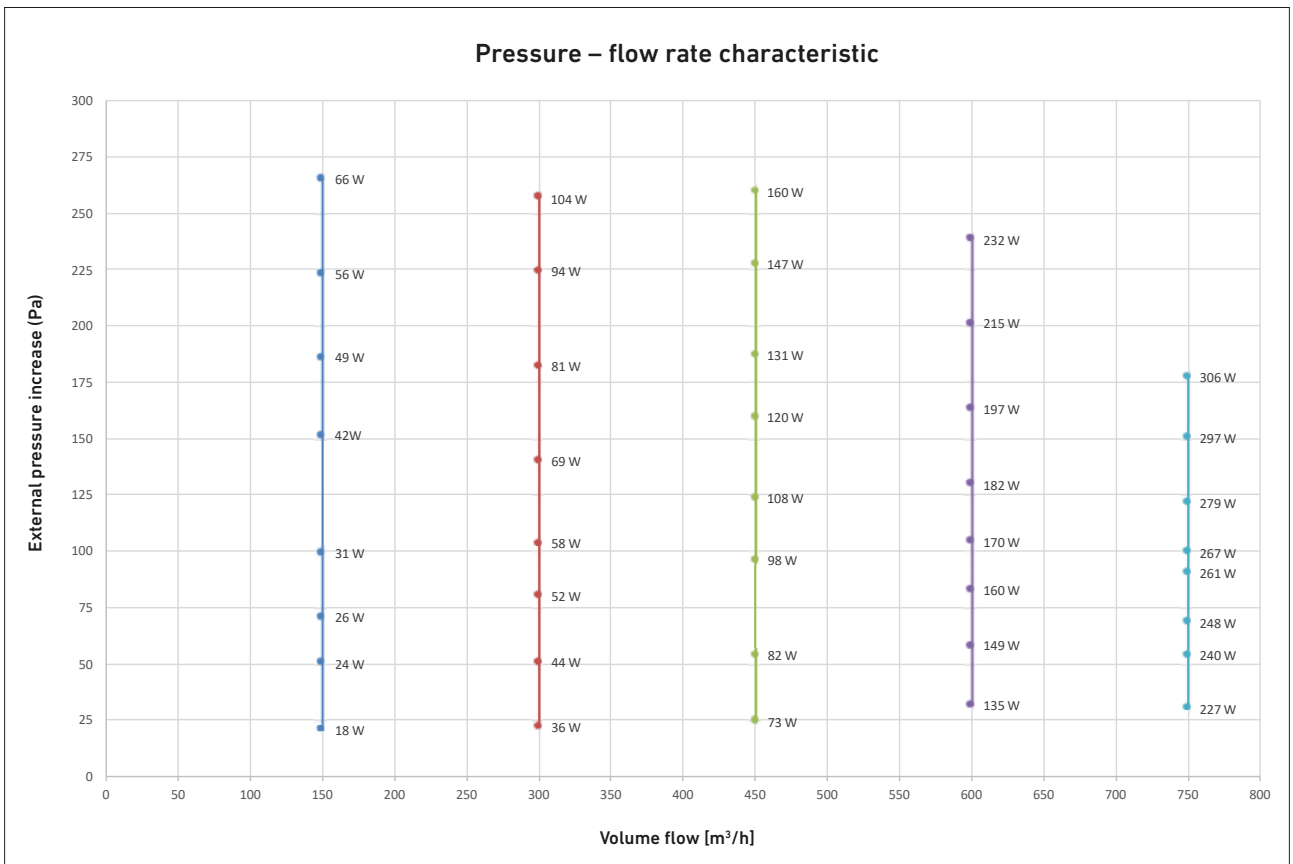

Hygiene certificate

The design meets hygiene requirements in accordance with the specifications of VDI 3803, SWKI VA104-01 and ÖNORM H 6021 in accordance with the hygiene assessments carried out.

Safety-related inspection with ÖVE (Austrian Federation for Electrical Engineering) safety mark in compliance with the test report.

Hygiene-Institut des Ruhrgebiets
 Institut für Umwelthygiene und Toxikologie
 Director: Dr. Thomas-Benjamin Seiler
 Legal Entity: Verein des Hygiene-Instituts des Ruhrgebiets e.V.



Hygiene-Institut - PO Box 10 12 55 - DE 45812 Gelsenkirchen - Germany

Address:
 Rotthausener Str. 21, DE 45879 Gelsenkirchen

Switchboard +49 (0)209 9242-0
 Telefax +49 (0)209 9242-222
 Internet www.hyg.de

Our reference: W-386099e-24-Zd
 Contact person: B. Zeidler

Gelsenkirchen, 08.05.2024

Test - certificate

hygiene-conformity check to the design requirements of selected regulations

Test institute: Hygiene Institut des Ruhrgebiets
 Institut für Umwelthygiene und Toxikologie
 Rotthausener Straße 21
 45879 Gelsenkirchen

Test object: "LG 740"

Manufacturer: J. Pichler Lufttechnik Gesellschaft m.b.H.
 Karlweg 5
 A-9021 Klagenfurt
 Österreich



Basis of the examination: ✓ VDI 6022, sheet 1 (01/2018) ✓ ÖNORM H 6021 (01/2023)
 ✓ SWKI VA104-01 (01/2019)

Validity period: 5 years 05/2024 – 05/2029

Test report: W-386099-24-Zd

In conclusion it can be stated that the examined "LG 740", as specified in the test report W-386099-24-Zd, is in compliance with the above mentioned regulations.

(B. Zeidler)
 clerk of the Department hygienic building technology

(J. Rolle B. Eng.)
 clerk of the Department hygienic building technology

issued 08.05.2024, Gelsenkirchen

Within the framework of the conformity check the hygiene-relevant requirements of the above mentioned regulations was examined. Requirements of other regulations that refer to the above mentioned regulations were not part of the examination. Additionally, the conformity check does not include a toxicological or sensory testing of the introduced materials.

Legal Entity: Verein des Hygiene-Instituts des Ruhrgebiets e.V., Register: VR 519 Local Court Gelsenkirchen (Germany); VAT ID: DE125018358
 Directorate: Prof. Dr. Jürgen Kretschmann (Head), Andrea Henze, Joachim Luchte, Dr. Frank Obenaus, Dr. Thomas-Benjamin Seiler (Executive Member), Dr. Dirk Waider





TOUCH control unit

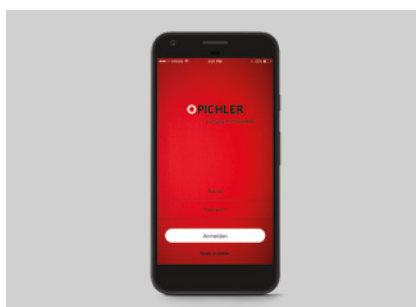

Pichler app



Swivel console

Operation

BYPASS FOR HEAT EXCHANGER

The 100% bypass will be regulated as a function of the measured extract air or outdoor air temperature. The heat exchanger may thus be bypassed in the summer, blowing cool outdoor air into the living space.

CONTROLLER

The control is equipped with a variety of functions already in its standard version. This includes a Modbus RTU interface for connection to a building management system. If required, communication with a KNX bus system can also take place via an optional gateway.

In addition, CO₂ and humidity sensors can be connected to the controller.

It is operated as standard using the Mini or (optional) Touch control unit.

MINI CONTROL UNIT

The MINI control unit is used to operate the ventilation unit. It is easy to operate and enables the configuration of ventilation levels, switching between summer and winter mode, setting of basic volume flow, etc. In addition, the control unit displays the operating status, need for filter change and any errors. The standard equipment includes the USB interface in the control unit. It is installed in a flush-mounted box or on the ventilation unit (on the mounting bracket).

TOUCH CONTROL UNIT

The control unit with 4.3" colour touch display is used to operate the ventilation unit. Operation is easy and intuitive. The most important settings and readings are very easy to make. The user-friendly handling provides for automatic or manual setting of the ventilation levels. In Automatic mode, the system is controlled by programmable time programmes, closed-loop humidity or CO₂ controls and works in a fully automated fashion,

whereas in manual mode ventilation levels may, for instance, be individually increased (boost ventilation). Further functions are the changeover function between summer and winter operation and the setting for the volume flows. The operating mode, temperatures, a required filter change and possible faults are displayed in plain text. The control unit also has an integrated temperature sensor that can be used as a room temperature sensor if required. It is installed on a flush-mounted box (not included in the delivery) or directly on the compact ventilation unit using the swivelling bracket.

Advantages of control:

- Simple display of the current operating parameters
- Individually adjustable air volumes
- Time and week program (only with TOUCH)

Item	Article number
STANDARD: MINI control unit for LG 740	08LGMINI740
OPTIONAL: TOUCH control unit for LG 740	08LG740T
Swivel bracket for attaching the TOUCH or MINI control unit directly to the ventilation unit	Included in the scope of delivery

EASY OPERATION WITH THE PICHLER APP

User-friendly: The compact ventilation unit can be operated easily with the free smartphone app for Android and iOS, whether you are at home or out and about.

REMOTE ACCESS / PICHLER CONNECT

Operational safety: Remote access allows the Pichler customer service to respond quickly and easily in the event of faults.

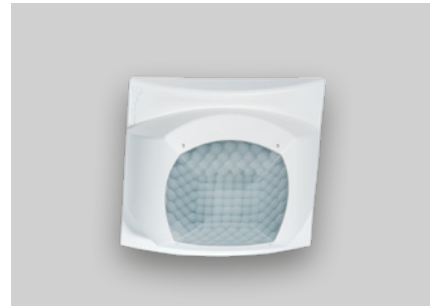

CO₂ sensorWireless room temperature, humidity and CO₂ sensor with Modbus communication

Presence detector

Demand-based ventilation control

CO₂, humidity and room temperature sensors for demand-based ventilation control. The ventilation unit will automatically increase or reduce the air volumes depending on the quality of the indoor air. The sensor in the surface-mounted housing is suitable for wall installation.

CO₂ SENSOR

Colour: white

Dimensions: W x H x D = 85 x 85 x 35 mm

Ambient temperature: 10-50 °C

Measurement range: 0-2000 ppm

Supply voltage of the sensors: 24V AC/DC

Guide signal: 0-10 V

Item	Article number
CO ₂ sensor	07RCO248330

HUMIDITY SENSOR

Colour: white

Dimensions: W x H x D = 85 x 85 x 35 mm

Ambient temperature: 0-60 °C (non-condensing)

Measurement range: 0-100% RH

Supply voltage of the sensors: 24V AC/DC

Guide signal: 0-10 V

Item	Article number
Humidity sensor	07RHF49360

ROOM TEMPERATURE SENSOR

Type of room temperature sensor: NTC 10k

Dimensions: W x H x D = 85 x 85 x 35 mm

Item	Article number
Room temperature sensor	07RTF49357

WIRELESS ROOM TEMPERATURE, HUMIDITY AND CO₂ SENSOR WITH MODBUS COMMUNICATION

Colour: white

Dimensions: W x H x D = 70 x 70 x 30 mm

Measurement range: 400-2000 ppm, accuracy: ±(30 ppm + 3%)

Temperature measuring range: 0-45 °C, accuracy: ±3%

Measurement range: 11-89% RH, accuracy: ±3%

Supply voltage of the sensors: 12-24 VDC

Item	Article number
Room temperature, humidity and CO ₂ sensor with Modbus communication (Modbus cable not included)	07RTRHC0248401

PRESENCE AND MOTION DETECTOR FOR FLUSH-MOUNTED, SURFACE-MOUNTED AND CEILING INSTALLATION

The flush-mounted presence detector for ceiling installation is ideally suited for presence areas in offices, conference rooms, lounges, cellar rooms, etc.

Technical specifications:

Voltage: 230 V AC

Potential-free normally open contact 10 A

DETECTION ZONE:

Ceiling height: 3 m

2 detection zones: Presence detector: detects seated or other stationary activities = 4 x 4 m. Motion detector: detects movements of objects with body temperature = 8 x 8 m

Detection zone: 360°

Degree of protection: IP40 indoor installation

Visible dimensions: W x H x D: 88 x 88 x 35 mm

Dimensions: W x H x D: 84 x 84 x 35,1 mm

Item	Item number
Presence detector	07UPPM360





Modbus/MiWi Gateway



Wireless room temperature and humidity sensor with/without CO₂ for surface installation



Modbus/KNX Gateway

WIRELESS ROOM TEMPERATURE, HUMIDITY AND/OR CO₂ SENSORS WITH MODBUS/MIWI COMMUNICATION FOR DEMAND-BASED VENTILATION CONTROL.

The Modbus/MIWI gateway is a receiver for wireless sensors and communicates via 0-10V output or via ModBus. The receiver is delivered in an external box for connection to the ventilation unit. The receiver should be installed outside the ventilation unit. This provides the best signal reception from the wireless sensors. The measurements of the wireless sensors are sent to the receiver via MiWi. Under normal circumstances, the range is approx. 20 m, which can be extended by setting up repeaters. The sensor and network number can be easily set with the DIP switch under the lid. If a 0-10V signal is used, only one sensor's signal can be received. Up to 6 wireless sensors can be connected via ModBus.

MODBUS/MIWI GATEWAY

- *Dimensions:* W x H x D = 138 x 64 x 30 mm
- *Number of controllable radio sensors via Modbus output:* up to 32
- *Number of controllable radio sensors via 0-10V output:* 1
- *Number of 0-10V outputs:* 4
- *Additional interface:* MiWi Mesh 868MHz
- *IP protection class:* IP 20
- *Supply voltage:* 15 – 24VDC
- *Ambient temperature during operation:* 0 – 40 °C

Item	Article number
Modbus/MiWi Gateway	07GATEWAYMIWI

WIRELESS ROOM TEMPERATURE AND HUMIDITY SENSOR FOR SURFACE INSTALLATION

- *Dimensions:* W x H x D = 85 x 85 x 30 mm
- *Supply voltage:* Battery 3 x 1.5V alkaline AA
- *Battery life:* up to 4 years
- *Temperature sensor accuracy:* 2%
Measurement range: 0 – 40 °C
- *Humidity sensor accuracy:* 4%
Measurement range: 0 – 80% RH
- *IP protection class:* IP 22
- *Ambient temperature during operation:* 0 – 40 °C

Item	Article number
Wireless room temperature and humidity sensor for surface installation	07MIWIRTRH

WIRELESS ROOM TEMPERATURE, HUMIDITY AND CO₂ SENSOR FOR SURFACE INSTALLATION

- *Dimensions:* W x H x D = 85 x 85 x 30 mm
- *Supply voltage:* Battery 3 x 1.5V alkaline AA
- *Battery life:* up to 2 years
- *Temperature sensor accuracy:* 2%
Measurement range: 0 – 40 °C
- *Humidity sensor accuracy:* 4%
Measurement range: 0 – 80% RH
- *Probe accuracy CO₂:* 0 – 2000 ppm
Measurement range: 0 – 10000 ppm
- *IP protection class:* IP 22
- *Ambient temperature during operation:* 0 – 40 °C

Item	Article number
Wireless room temperature, humidity and CO ₂ sensor for surface installation	07MIWIRTRHCO2

MODBUS/KNX GATEWAY

The Modbus/KNX gateway allows for the connection of the ventilation unit to a KNX bus system. In this process, the gateway serves as a connective link between the two bus systems. Note that the master is always on the Modbus. On the KNX side, however, it responds like a common KNX TP-1 unit. This makes it possible to centrally control and monitor the ventilation unit by a KNX system. In order to facilitate the configuration, ETS template projects are provided for download for a variety of ventilation units.

- Dimensions:* L x W x D = 18 x 100 x 60 mm
- Mounting:* top hat rail or wall
- Permissible ambient temperature:* -5 to 45 °C
- Permissible humidity:* 5 – 93 % non-condensing
- Protection class:* IP20
- Voltage:* 12...24V DC
- Interfaces:* Ethernet, EIA-485, KNX-TP1

Item	Item number
Modbus/KNX Gateway	08KNXGAB

BACNET GATEWAY

The BACnet GATEWAY enables the connection of the classroom floor-mounted unit LG 1000 SKS to a BACnet bus system. In this process, the gateway serves as a connective link between the two bus systems.

Item	Article number
BACnet GATEWAY	08BACGAES2020





External dual pressure sensor set



Hot water heating coil



Electric heating coil for duct installation

Accessories

SPARE FILTER

Ensures perfect hygiene and air quality given regular replacement, also proper functionality and efficient operation of the equipment.

Item	Article number
ETA filter ISO Coarse 70% (extract air)	40LG0500025A
ODA filter ISO ePM1 55% (outdoor air)	40LG0500024A

EXTERNAL DUAL PRESSURE SENSOR SET

Pressure sensors for external mounting including a connection kit. Serves to ensure constant pressure control of the ventilation unit.

Item	Article number
External dual pressure sensor set with Modbus communication	08LGDRUCKDUALSET

COIL FOR INSTALLATION INTO THE SUPPLY LINE

Recommended below 500 m ³ /h	
Item	Article number
Combination exchanger (cold water coil) for duct installation Ø 200 mm	01CWK200
Hot water heating coil for duct installation Ø 200 mm	01VBC200
Additionally for water coils:	
DN15 KVS 1.00 three-way valve with LR24ASR actuator	07R30151SLR24ASR
Electric heating coil for duct installation Ø 200 mm	08CV20121MTXL
Refrigerant coil (heating or cooling) for duct installation Ø 200 mm	01CWDX200
Additionally for refrigerant coils:	
Coupling relay with screw terminals 2W, 8A, 230VAC	40LG0400100A

Recommended over 500 m ³ /h	
Item	Article number
Combination exchanger (cold water coil) for duct installation Ø 250 mm	01CWK250
Hot water heating coil for duct installation Ø 250 mm	01VBC250
Additionally for water coils:	
DN15 KVS 1.00 three-way valve with LR24ASR actuator	07R30151SLR24ASR
Electric heating coil for duct installation Ø 250 mm	08CV25181MTXL
Refrigerant coil (heating or cooling) for duct installation Ø 250 mm	01CWDX250
Additionally for refrigerant coils:	
Coupling relay with screw terminals 2W, 8A, 230VAC	40LG0400100A

EXTERNAL CABLE TEMPERATURE SENSOR

NTC thermistor sensor with metal sleeve required for operation of the coils installed into the air supply duct.

Item	Article number
NTC thermistor sensor, length 2 m	40LG041920

CONDENSATE SIPHON

DN40 condensate siphon with vertical connection 5/4", water odour seal (60 mm) and mechanical odour seal.

Item	Article number
Condensate siphon DN40 x 5/4"	40LG030620

SHUT-OFF VALVE

Shut-off valve, galvanised with double lip seal.

Item	Article number
Shut-off valve AKR Ø 200 mm with MOTOR LF 230	02AKR200LF230
Shut-off valve AKR Ø 250 mm with MOTOR LF 230	02AKR250LF230

DEFLECTION SILENCER

Square silencer with galvanised steel sheet housing. With integrated, efficient and technologically and acoustically optimised deflection silencer panels with absorption and resonance elements for optimal sound-proofing. The panels are not combustible and comprise a high-rigidity, abrasion-proof and moisture-repellent surface made of glass silk. The housing has air connection pieces with a double lip seal for plug-in installation. The silencer can be positioned directly above the unit.

- **Material:** sheet steel, galvanised
- **Dimensions:** W x H x L = 240 x 380 x 1000 mm
- **Panels with glass silk surfaces**
- **Air connection:** Ø 200 mm (SAFE system)
- **Attenuation at 250 Hz: 20 dB**

Item	Article number
Deflection sound absorbers	08USD200G

COMPLETE RANGE FOR AIR DISTRIBUTION SYSTEMS

We offer a complete range of air distribution systems, such as Komflex round or oval. Refer to the technical documentation for details on our range of components.



Installation example for residential complex

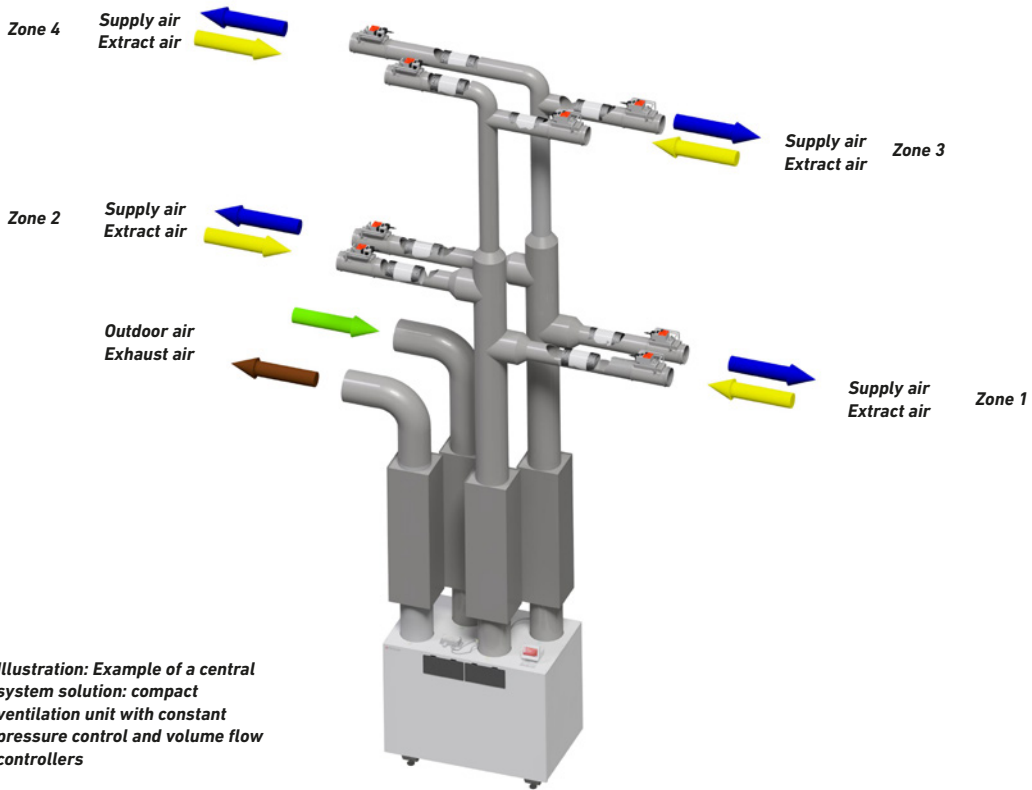

Installation example for a school classroom

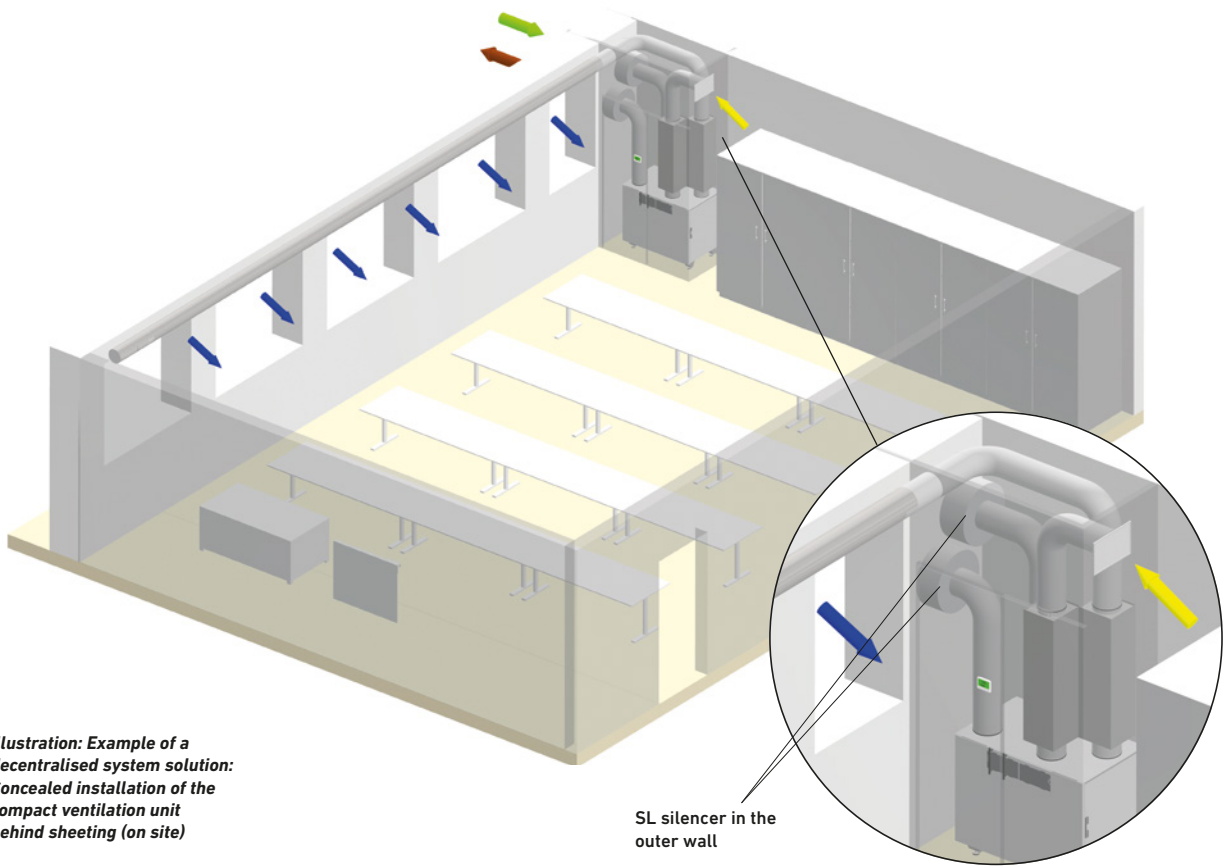

Illustration: Example of a decentralised system solution: Concealed installation of the compact ventilation unit behind sheeting (on site)

SL silencer in the outer wall



LG 740 at a glance

Fans:

Energy-saving radial fans with DC technology (the latest EC motor technology).

Counterflow heat exchanger:

Highly efficient heat recovery system with air/air counterflow heat exchanger with an automatic 100% bypass

Air flow volume:

Up to approx. 750 m³/h with external pressure up to 150 Pa

Filter:

ODA filter ISO ePM1 55% for outdoor air and ISO Coarse 70% for extract air

Electric pre-heating coil for frost protection: 2400 W, with infinitely variable control, optional

Housing:

Made of galvanised steel sheet, powder-coated in RAL 9003 with thermal insulation

Air connections:

Left and right side version.
ODA/EHA/SUP/ETA: each Ø 200 mm

Installation position:

Free standing

Summer changeover:

Integrated 100% bypass flap

Electrical connection:

Delivered ready to plug in

Operation:

Control unit MINI, TOUCH (optional) and via the Pichler app when connected to the Internet (LAN connection)

Optional constant pressure control:

External dual pressure sensor set with Modbus communication

Service – Maintenance – Commissioning

OUR LG 740 COMPACT VENTILATION UNIT WAS EXTERNALLY TESTED BY

- TÜV SÜD Munich

OUR LG 740 COMPACT VENTILATION UNIT IS LISTED IN THE

- EPREL – European Product Database for Energy Labelling

OUR COMPACT VENTILATION UNIT LG 740 MEETS

- the hygienic requirements of VDI 6022

Note:

Our product range includes device sizes up to 10,000 m³/h and extensive accessories.





ErP 2018

Fulfills the requirements of the Ecodesign Directive, in accordance with EU Regulation 1253/2014.



EPREL according to Regulation (EU) No. 1369/2017

In accordance with VO (EU) No. 1369/2017 – Energy Labelling, European Product Database, the ventilation unit is listed in the EPREL database.



Your partner/installer:



Responsible for the content: J. Pichler Gesellschaft m.b.H. | Graphics and layout: WERK1
Photos: J. Pichler Gesellschaft m.b.H. | Text: J. Pichler Gesellschaft m.b.H.
All rights reserved | All photos are symbolic photos | Subject to change without notice | Version: 09/2024 en/p



J. PICHLER
Gesellschaft m.b.H.
office@pichlerluft.at
www.pichlerluft.at

AUSTRIA
9021 KLAGENFURT
AM WÖRTHERSEE
Karlweg 5
T +43 (0)463 32769
F +43 (0)463 37548

AUSTRIA
1100 WIEN
Doerenkampgasse 5
T +43 (0)1 6880988
F +43 (0)1 6880988-13

Sales offices in Germany, Slovenia and Serbia.
Sales partners in Europe.